

**Military Qualified Amplifier**

**DESCRIPTION**

The MA11M Military Qualified Amplifier (MA11M) is designed for use with thin link margins of satellite navigation systems in mind; and is a single stage gain block that covers the GPS, Galileo, and GLONASS frequencies. The device features 30dB of gain and excellent gain flatness of less than 1dB.

The MA11M is for military applications and environments where high reliability is required. It has been designed to the following MIL standards.

MIL Standards		
MIL-STD-810	MIL-STD-704	MIL-STD-1587
MIL-STD-1472	MIL-E-5400	MIL-STD-461
MIL-STD-202	MIL-HDBK-454	MIL-STD-1275B
MIL-STD-883		

**FEATURES**

- Designed and Manufactured to Military Specifications
- Excellent Gain:  $G = 30\text{dB}$
- Excellent Gain Flatness:  $\text{Gain} | L1 - L2 | < 2\text{ dB}$
- Passes GPS, Galileo, and GLONASS L1/L2
- RoHS and WEEE Compliant

**OPTIONS**

The MA11M amplifier can be custom configured. Please contact GPS Source for further information on product options and specifications.

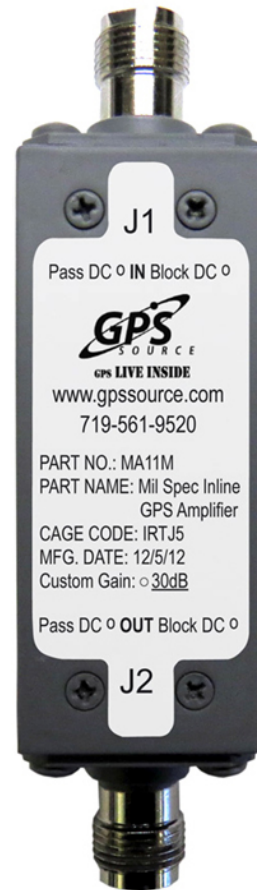

# 1 MA11M Electrical Specifications

## 1.1 Electrical Specifications

**Table 1-1. Electrical Specifications**

Operating Temperature -40°C to 85°C

Parameter	Conditions	Min	Typ	Max	Units	
Frequency Range	IN – OUT, IN/OUT 50Ω	1		1.7	GHz	
Impedance	IN, OUT		50		Ω	
Gain	IN – OUT, IN/OUT 50Ω	1227MHz	30	31	32	dB
		1575MHz	30	31	32	
Input SWR	OUT Port 50Ω			2:1	—	
Output SWR	IN Port 50Ω			2:1	—	
Noise Figure	Antenna Any Port, Unused Ports 50Ω			3.2	dB	
Gain Flatness	[L1 – L2], Antenna Any Port, Unused Ports 50Ω			2	dB	
Group Delay Flatness	$T_{d,max} - T_{d,min}$ , IN-OUT			1	ns	
Reverse Isolation	OUT – IN	30			dB	
Input IP <sub>3</sub>	IN – OUT, IN/OUT 50Ω; Gain = 30dB, Tone Spacing = 1MHz	-12			dBm	
Input P <sub>1dB</sub>	IN – OUT, IN/OUT 50Ω; Gain = 30dB	-22			dBm	
DC IN	Non-Powered Configuration, DC Input on OUT port	5		7	VDC	
Device Current	Current Consumption of Device			65	mA	
Ant/Thru Current	Pass DC Non-Powered Configuration, DC Input on OUT port			250	mA	
Max RF Input	Max RF Input Without Damage			30	dBm	

## 1.2 General Specifications

**Table 1-2. General Specifications**

Description	Measurement
Weight	0.25lbs (113.4g)
Mean Time Between Failure (MTBF) <sup>(1)</sup>	527,729 at 29°C
	286,916 at 71°C

1. Calculation derived using Airborne Inhabited Cargo parameters per MIL-STD-217F

## 2 Performance Data

### 2.1 MA11M

Figure 2-1. Gain vs. Frequency

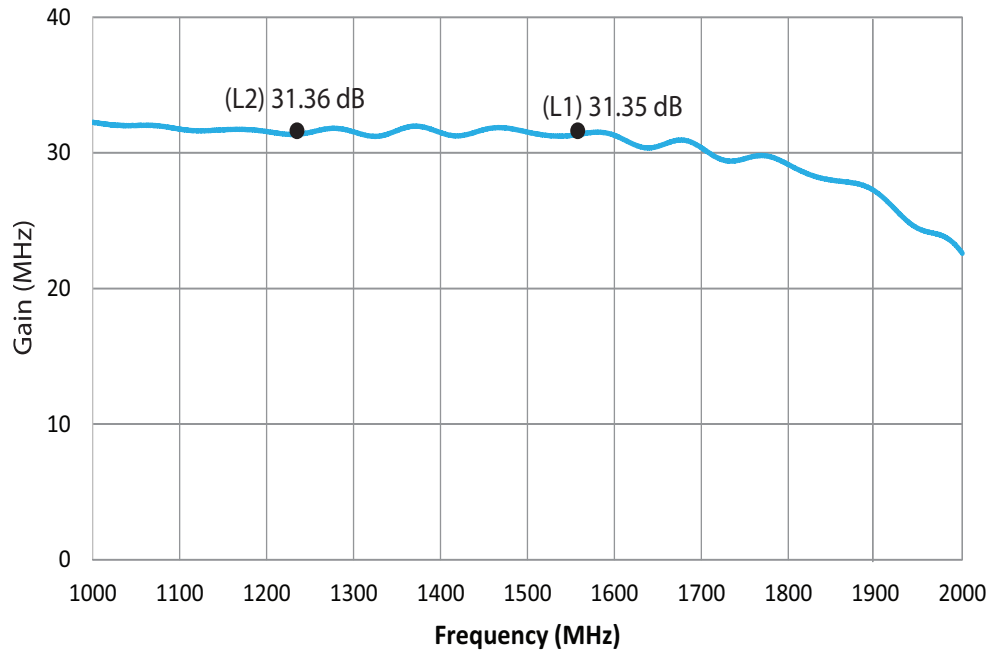
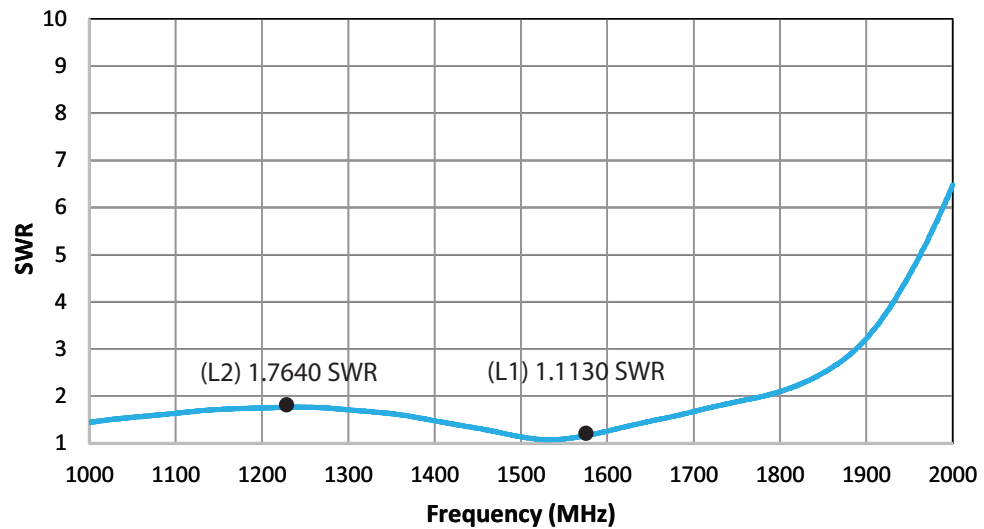

Figure 2-2. SWR vs. Frequency



---

## 3 Environmental Requirements

### 3.1 Temperature and Altitude

The MA11M complies with the temperature-altitude tests per MIL-STD-810C, Method 504, and Procedure 1 Equipment Category 5.

### 3.2 Explosive Atmosphere

The MA11M is designed for operation in the presence of explosive mixtures of air and jet fuel without causing explosion or fire at atmospheric pressures corresponding to altitudes from -1,800ft to 50,000ft. The MA11M does not produce surface temperatures or heat in excess of 400°F. The MA11M does *not* produce electrical discharges at an energy level sufficient to ignite the explosive mixture when the equipment is turned on or off or operated. The MA11M meets the requirements of MIL-STD-810C, Method 511.1, and Procedure II. Hermetically sealed equipment meeting the Requirements of MIL-STD-202, Method 112D, or MIL-STD-883, Method 1014.7 (as applicable), and not exceeding a Helium leakage rate of  $1 \times 10^{-7}$  cc/sec, are exempt from this requirement.

### 3.3 Salt Fog

The MA11M is designed to meet the requirements of Salt Fog conditions per Paragraph 3.2.24.9 of MIL-E-5400 and MIL-STD-810C Method 509.1. The MA11M is designed to withstand a salt concentration of five percent at a temperature of 35°C for 48 hours without degradation.

### 3.4 Fungus

The MA11M is designed to meet the requirements of fungus conditions per Paragraph 3.2.24.8 of MIL-E-5400 and MIL-STD-810C Method 509.1 i.e. fungus inert materials per Requirement 4 of MIL-HDBK-454.

### 3.5 Humidity

The MA11M is designed to withstand a 10 day humidity test conducted per MIL-STD-810C, Method 507.1; Procedure I. MA11M can withstand exposure to 95% relative humidity at a temperature of 30°C for 28 days.

### 3.6 Sand and Dust

The MA11M is designed to withstand the conditions of method MIL-STD-810C, Method 510, for a temperature of 145°F for duration of 22 hours.

### 3.7 Decompression

The MA11M is designed to meet the performance standards per RTCA-DO-160E Paragraph 4.6.2 Category D during and following a rapid and complete loss of normal cabin compartment pressurization (10,000 feet) from an airplane flight altitude of 50,000 feet within 15 seconds. The MA11M will remain operating for five minutes at 50,000 feet before being returned to normal cabin pressure.

### 3.8 Overpressure

MA11M is designed to be capable of withstanding, for 10 minutes, while not operating, a 12.1psi compartment pressure with no physical distortion or permanent set per RTCA-DO-160E Paragraph 4.6.3. The MA11M will operate satisfactorily upon return to normal pressure.

### 3.9 Temperature Shock

The MA11M is designed to operate without degradation (while not operating) Method 503.1, Procedure I of MIL-STD-810C.

### 3.10 Flammability

The MA11M is self-extinguishing or nonflammable and is designed to meet the Requirements of Paragraph 5.2.4 of MIL-STD-1587 and Requirement 3 of MIL-HDBK-454.

### 3.11 Finish and Colors

All case surfaces of the MA11M are treated with chemical film per MIL-DTL-5441, Type II, Class 3. The MA11M bottom contact surface is free of paint or non-conductive finishes. The MA11M bottom contact surfaces are protected from corrosion by a conductive coating (MIL-DTL-5541). All other surfaces, except connector mating surfaces are primed per MIL-PRF-23377, Type 1 Class C and painted per MIL-PRF-85285, Type 1 Color Number (26231), Military Gray (not lusterless variety) per FED-STD-595 (Exceptions: bottom and connector surfaces are free of paint).

### 3.12 Human Factors

Human Engineering principles and criteria (including considerations for human capabilities and limitations) using MIL-STD-1472 in all phases of design, development, testing, and procedures development. The design is free of all sharp edges, according to MIL-STD-1472.

### 3.13 Shock

The MA11M is designed to withstand the shock levels specified in the saw tooth shock pulse parameter specified in Figure 3-1 and Table 3-1.

Figure 3-1. Peak Shock Levels

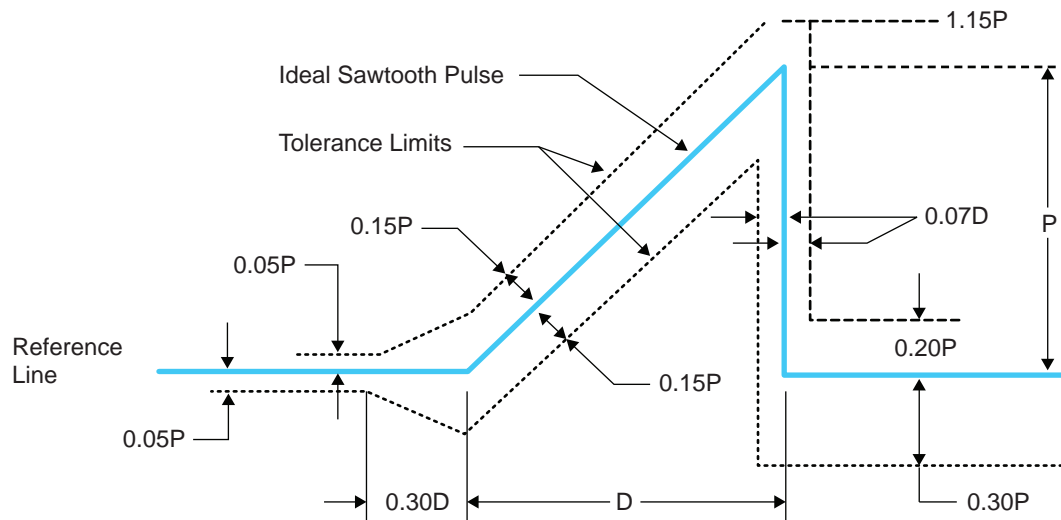

Table 3-1. Peak Shock Levels

Test	Flight Vehicle Equipment	
	Minimum Peak Value (P) g's	Nominal Duration (D) ms
Functional	20	11
Crash Safety	40	11

### 3.14 Vibration

The MA11M is designed to meet the requirements of random vibration per conditions (MIL-STD-810C, Method 514.2, Procedure 1A) to the levels defined below. Acceleration Power Spectral Density (PSD) for the random vibration envelope is shown in Figure 3-2. Amplitudes for the functional levels and endurance level requirements are as shown in Table 3-2.

Figure 3-2. Zone 3 and 4 Broadband Random Vibration

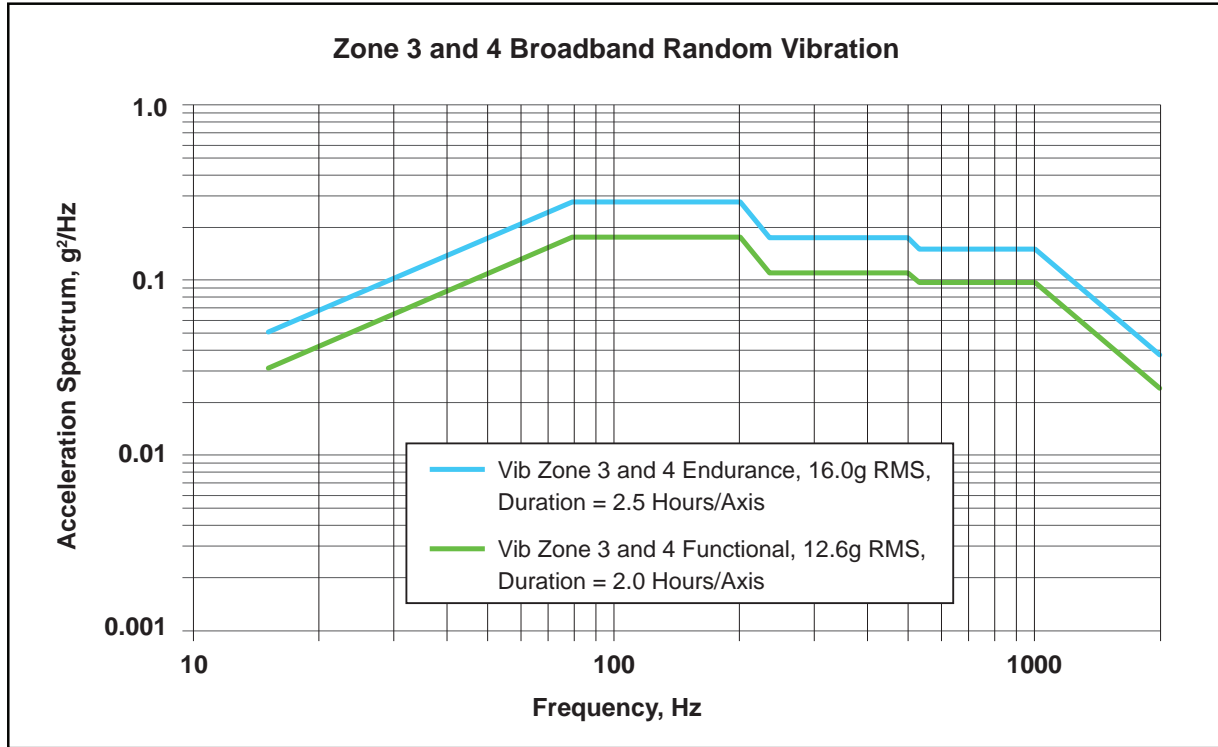

Table 3-2. Vibration Zone 3 and 4

Vibration Zone 3 and 4 Functional, 12.6g RMS Duration = 2 Hours/Axis	
Freq. Hz	g <sup>2</sup> /Hz
15	0.033
80	0.177
200	0.177
234	0.111
500	0.111
535	0.097
1000	0.097
2000	0.024

### 3.15 Electromagnetic Interference and Compatibility Test

The MA11M performs its intended function, and its operation does not degrade the performance of other equipment or subsystems. The MA11M is designed to meet the requirements of MIL-STD-461F:

**Table 3-3. Compatibility Test**

Test	Description
CS101	Conducted Susceptibility Power Leads 30Hz to 150kHz
CS103	Conducted Susceptibility Antenna Port Intermodulation 15kHz to 10GHz
CS105	Conducted Susceptibility, Antenna Port, Cross-Modulation, 30Hz to 20GHz
CS114	Conducted Susceptibility Bulk Cable Injection 10kHz to 200MHz
RE102	Radiated Emissions Electric Field 10kHz to 18GHz
RS103	Radiated Susceptibility Electric Field 2MHz to 18GHz
Indirect Lightning	Damped Sinusoidal Transients RF Leads 10kHz to 100MHz
	Damped Sinusoidal Transients Power Leads 10kHz to 100MHz

## 4 Product Options

Table 4-1. MA11M Available Options



### Electrostatic Sensitive Device (ESD)

Remove electrostatic protection at use or in a protected area. Reuse packaging materials for the unserviceable item. See DOD-HDBK-263 for protective handling or testing measures for this item.

RF Connector		
Connector	Connector Type	Limitations
	N (Female/Male)	N/A
	SMA (Female/Male)	N/A
	TNC Female/Male)	N/A
Housing		
Housing	Housing Type	Limitations
	Mini	Powered Option is Not Available
Port <sup>(1,2)</sup>		
Configuration	Pass DC <sup>(1)</sup>	IN Port Passes DC
	DC Blocked <sup>(1)</sup>	IN Port Blocks DC

- Notes:
1. Powered Option: any or all RF ports (input or output) can be DC Blocked or can pass the powered DC voltage.
  2. Maximum combined DC current draw out all ports of the device is a function of the DC input voltage and desired DC output voltage according to the following:

$$I_{out} \leq 1.4 / (VDC\ IN - VDC\ OUT) - 0.007\ Amps\ (or\ 250mA\ max)$$

For powered option with a wall mount transformer (Voltage Input = 110/220/240VAC), VDC IN is 9V.

## 5 Product Code Decoder

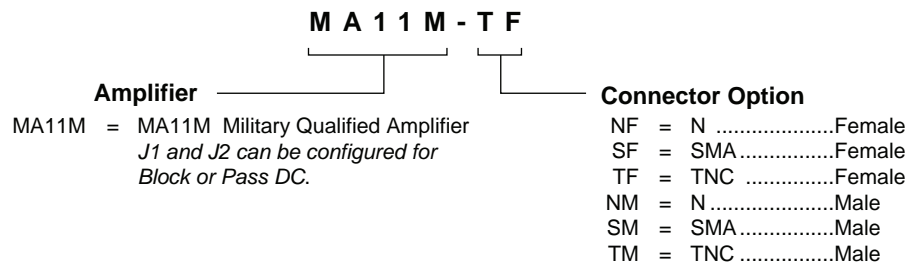



# 6 Mechanical Drawing

## MA11M Military Qualified Amplifier — FAM-ACM-EEX-AG

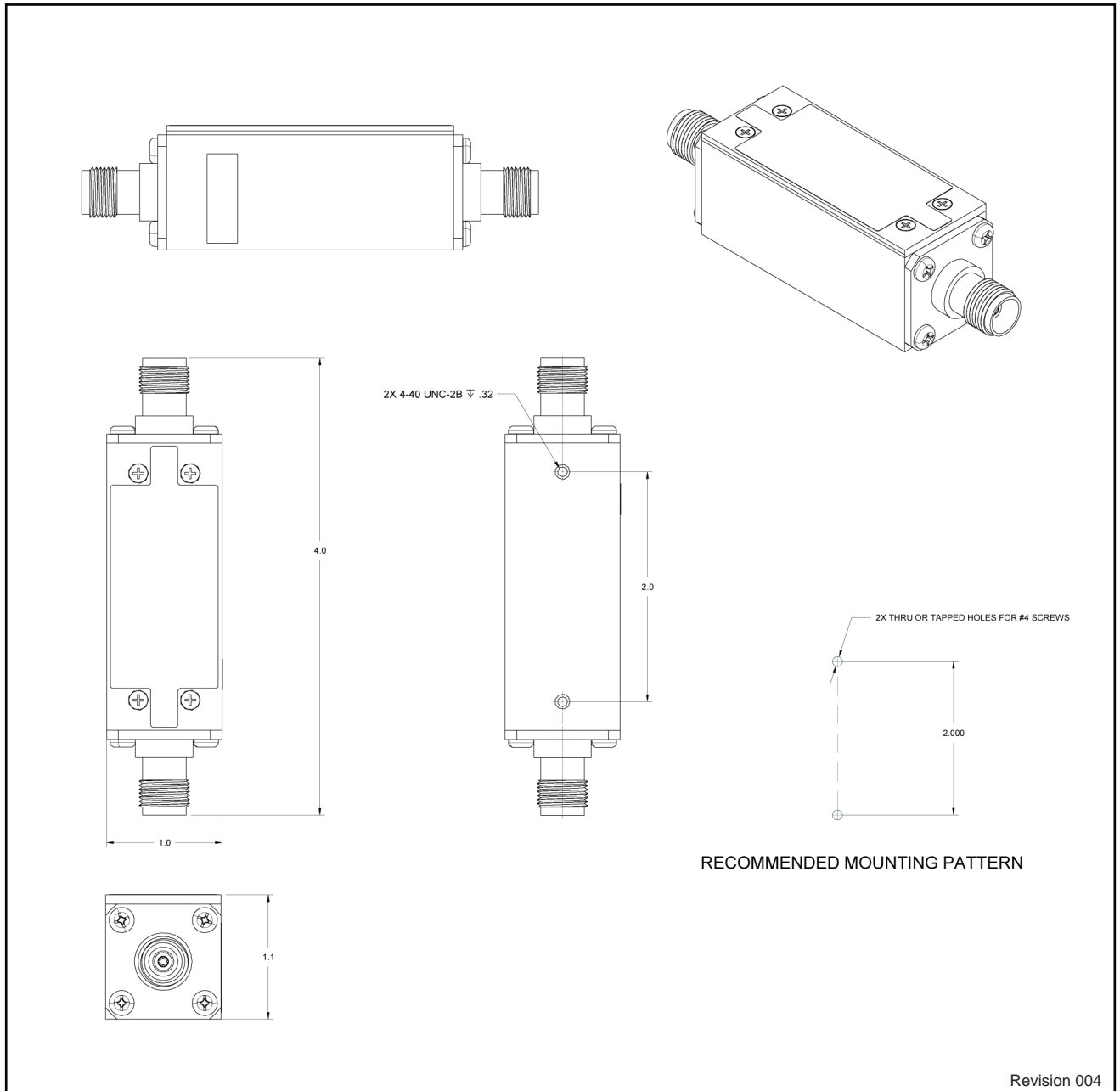

GPS Source Part No. <b>FAM-ACM-EEX-AG</b>		Finish <b>N/A</b>	Size <b>C</b>	Mass	Tolerances	
Description <b>MA11M Military Specification Mini 30dB Amplifier</b>		Material <b>N/A</b>	3 <sup>rd</sup> Angle Projection 		Linear	Angular
All materials and finishes shall comply with European Union RoHS and are lead free. Dimensions are in inches unless otherwise specified.						



**GPS LIVE INSIDE**

## **MA11M Military Qualified Amplifier Data Sheet**

059-FAM-ACM-EEX-AG-006

Page 10 of 10, 06/01/17

64 N. Mission Drive  
Pueblo West, CO 81007  
Phone: (+1)(719) 561.9520  
Fax: (+1)(719) 565.0890  
[techsales@gpssource.com](mailto:techsales@gpssource.com)  
[www.gpssource.com](http://www.gpssource.com)

AS9100C:2009 and ISO 9001:2008 Compliant Company



© 2014 GPS Source, Inc. All rights reserved.

GPS Source, Inc., GPS Live Inside, GPS Source logo, and other GPS Source, Inc. products, brands, and trademarks mentioned in this document are property of GPS Source, Inc. and/or its affiliates in the United States and/or other countries. Other products, brands, and trademarks are property of their respective owners/companies. Any rights not expressly granted herein are reserved.

DISCLAIMER: The materials in this document could include inaccuracies or typographical errors and are subject to change at any time. The materials are provided "as is" without warranty of any kind. To the maximum extent permitted by applicable law, GPS Source, Inc. and its suppliers hereby disclaim all warranties, either expressed or implied, and conditions with respect to the materials, their quality, performance, suitability, merchantability, fitness for a particular purpose, title, and non-infringement. LIMITATION OF LIABILITY: IN NO EVENT WILL GPS SOURCE, INC. AND ITS SUPPLIERS BE LIABLE FOR INDIRECT, SPECIAL, INCIDENTAL, OR CONSEQUENTIAL DAMAGES, WHETHER IN AN ACTION OF CONTRACT OR TORT, ARISING OUT OF THE USE OR INABILITY TO USE THE MATERIALS AVAILABLE IN THIS DOCUMENT, EVEN IF ADVISED OF THE POSSIBILITY OF SUCH DAMAGES. IN PARTICULAR AND WITHOUT LIMITATION, GPS SOURCE, INC. SHALL HAVE NO LIABILITY FOR ANY LOSS OF USE, DATA, INCLUDING THE COSTS OF RECOVERING SUCH DATA, OR PROFITS.